

3W Stereo Class-D Audio Power Amplifier

BA20550

Data Sheet

Rev.1.1, 2007.02.12



Biforst Technology Inc.

3W Stereo Class-D Audio Power Amplifier

BA20550

GENERAL DESCRIPTION

The BA20550 is a 5V class-D amplifier from Biforst Technology. BA20550 provides dc volume control, lower supply current, high efficiency & few external components for driving speaker directly. BA20550 also integrates Anti-Pop, Output Short & Over-Heat Protection Circuitry to increase device reliability. The functionality makes this device ideal for LCD projectors, LCD monitors, powered speakers & other applications that demand more battery life.

FEATURE

- 3W Per Channel Into 3- Ω Speakers (THD+N = 10% @5V)
- Operation Voltage From 3.3 To 5.5V
- DC Volume Control From -27dB to 20dB
- Low Shutdown Control : <10 μ A
- Low Noise Floor, -80dBV
- Maximum Efficiency into 3- Ω , 77%
- Maximum Efficiency into 8- Ω , 87%
- PSRR, -71dB
- Filter Free PWM Output Technology without LC Output Filter
- Integrated Anti-Pop Circuitry
- Integrated Output Short Protection Circuitry
- Integrated Over-Heat Protection Circuitry
- Provide DC Volume Control
- Package Type: TSSOP24

APPLICATION

- LCD Monitors
- Powered Speakers
- Cellular Phones
- PDA
- Portable DVD/CD Players
- USB Audio
- Battery Powered Application

PIN ASSIGNMENTS

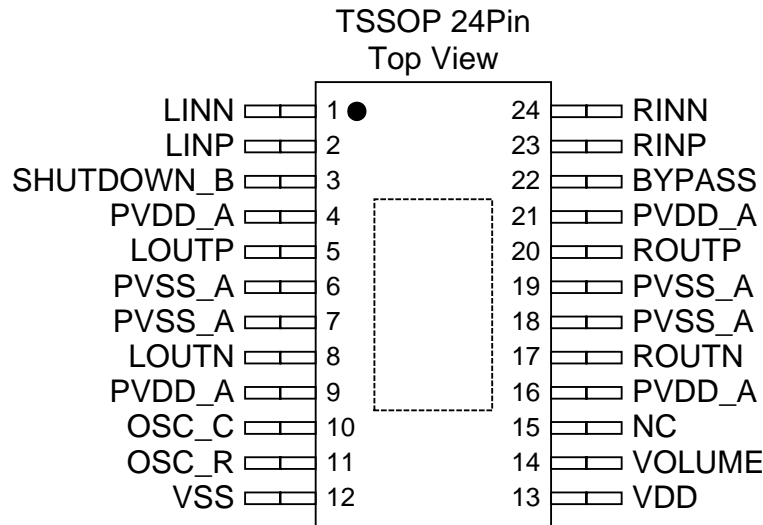

PIN LIST & DESCRIPTION

Pin No.	Pin	Type	I/O Pad Function
1	LINN	Input	Left channel negative differential audio input
2	LINP	Input	Left channel positive differential audio input
3	SHUTDOWN_B	Input	Shut down control for BA20550, Logic low is placed on this terminal for shut down mode, Logic high is placed on this terminal for normal operation <i>(Recommend Connect 100K Ohm To VDD & Connect 0.1uF To Ground In Application Circuit)</i>
4	PVDD_A	Power	5V power supply for left channel output
5	LOUTP	Output	Left channel positive output
6	PVSS_A	Power	5V ground for left channel output
7	PVSS_A		
8	LOUTN	Output	Left channel negative output
9	PVDD_A	Power	5V power supply for left channel output
10	OSC_C	Input	A capacitor connected to this terminal sets the oscillation in conjunction with OSC_C. For proper operation, connect a 220-pF capacitor from OSC_C to ground
11	OSC_R	Input	A resistor connected to this terminal sets the oscillation in conjunction with OSC_R. For proper operation, connect a 120-k Ω resistor from OSC_R to ground
12	VSS	Power	5V ground
13	VDD	Power	5V power supply
14	VOLUME	Input	DC volume control for setting the gain on the internal amplifier. The dc voltage range is 0 to VDD
15	NC		
16	PVDD_A	Power	5V power supply for right channel output
17	ROUTN	Output	Right channel negative output

Pin No.	Pin	Type	I/O Pad Function
18	PVSS_A	Power	5V ground for right channel output
19	PVSS_A		
20	ROUTP	Output	Right channel positive output
21	PVDD_A	Power	5V power supply for right channel output
22	C_BYPASS	Input	Connect a 1-uF capacitor from C_BYPASS to ground for internal bias reference
23	RINP	Input	Right channel positive differential audio input
24	RINN	Input	Right channel negative differential audio input

Function Block Diagram

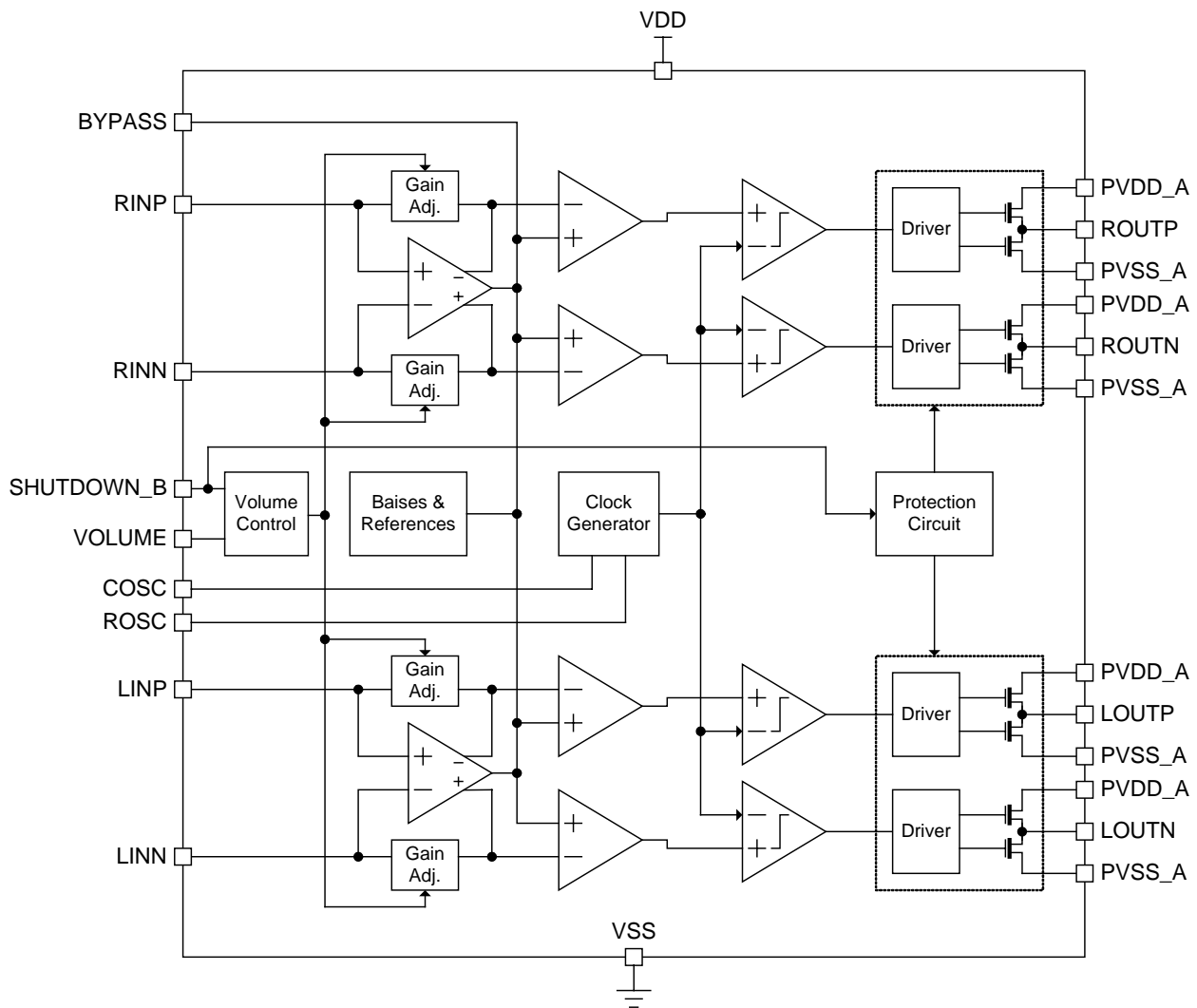

Absolute Maximum Ratings

SYMBOL	PARAMETER	VALUE
VDD, PVDD_A	Supply Voltage Range	-0.3V to 6V
V _I (RINP, RINN, LINP, LINN, VOLUME)	Input Voltage Range	0V to VDD
T _A	Operating Free-Air Temperature Range	-40°C to 85°C
T _J	Operating Junction Temperature Range	-40°C to 150°C
T _{STG}	Storage Temperature Range	-65°C to 85°C

Recommended Operating Conditions

SYMBOL	PARAMETER		MIN	MAX	UNIT
VDD, PVDD_A	Supply Voltage		3.3	5.5	V
	Volume Terminal Voltage	VOLUME	0	VDD	V
V _{IH}	High-Level Input Voltage	SHUTDOWN_B	2		V
V _{IL}	Low-Level Input Voltage	SHUTDOWN_B		0.8	V
f _{PWM}	PWM Frequency		200	300	KHz
T _A	Operating Free-Air Temperature		-40	85	°C
T _J	Operating Junction Temperature			125	°C

Electrical Characteristics TA = 25°C, VDD = PVDD_A = 5V (unless otherwise noted)

SYMBOL	PARAMETER	TEST CONDITIONS	SPECIFICATION			UNIT
			MIN	TYP	MAX	
$ V_{OS} $	Output Offset Voltage (Measured Differentially)	$V_I = 0V, A_V = 20dB, R_L = 8\Omega$		15	25	mV
PSRR	Power Supply Rejection Ratio	$V_{DD} = PVDD_A = 4.5 \text{ to } 5.5V$		-70		dB
$ I_{IH} $	High-Level Input Current	$V_{DD} = PVDD_A = 5.5V, V_I = V_{DD} = PVDD_A = 0V$			1	μA
$ I^{LL} $	Low-Level Input Current	$V_{DD} = PVDD_A = 5.5V, V_I = 0V$			1	μA
I_{DD}	Supply Current	No Filter (No Load)		10	20	mA
$I_{DD(MAX)}$	RMS Supply Current At Max Power	$R_L = 3\Omega, P_O = 2.5W/Channel$ (Stereo)		1.8		A
$I_{DD(SD)}$	Supply Current In Shutdown Mode	SHUTDOWN_B = 0V		1	10	μA
$r_{ds(on)}$	Drain-Source On-State Resistance	$V_{DD} = 5V, I_O = 500mA,$ $T_J = 25^\circ C$	High Side	550	700	m Ω
			Low Side	550	700	

Operating Characteristics TA = 25°C, VDD = PVDD_A = 5V, RL = 3Ω, Gain = 0dB (unless otherwise noted)

PARAMETER		TEST CONDITIONS		SPECIFICATION			UNIT
				MIN	TYP	MAX	
P_O	Output Power	$f = 1KHz, R_L = 3\Omega,$ Stereo Operation	THD+N = 1%		2.5		W
			THD+N = 10%		3.1		W
THD+N	Total Harmonic Distortion Plus Noise	PO = 1W, f= 20Hz to 20KHz			<0.3%		
		PO = 2.2W, f= 1KHz			0.22%		
BOM	Maximum Output Power Bandwidth	THD = 5%			20		KHz
SNR	Signal-to-Noise Rate	Maximum Output at THD+N < 0.5%			96		dB
	Thermal Trip Point				150		°C
	Thermal Hysteresis				20		°C
V_n	Integrated Noise Floor	20Hz to 20KHz, Input AC Grounded			45		μV_{rms}
					88		

Thermal Information

The BA20550 TSSOP 24Pin Package features an exposed thermal die pad. It can be directly attached to an external heat sink. That means, when the pad is soldered to PCB, the PCB can be used as a heat sink. Further, through the use of thermal vias, the pad can be attached to a ground plane or special heat sink structure designed into the PCB. This design optimizes the heat transfer from the BA20550.

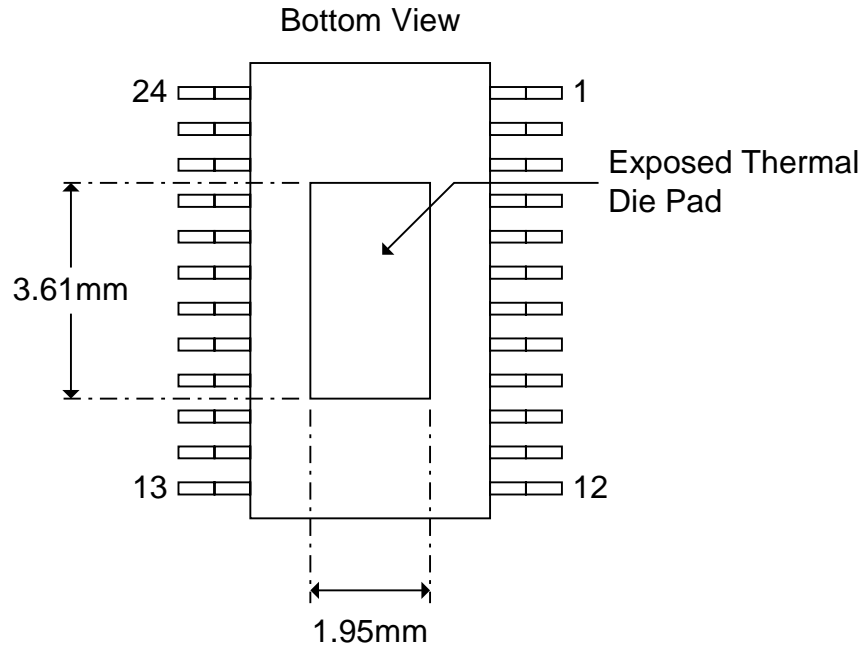

Figure 1: BA20550 TSSOP 24Pin Exposed Thermal Die Pad Dimensions

Function Description

Output Power Efficiency

The output transistors of BA20550 act as switches. The amount of power dissipated in the speaker may be estimated by first considering the overall efficiency of the system. If the on-resistance of the output transistors is considered to cause the dominant loss in the system. The on-resistance of output transistors is small that the power loss is small and the power efficiency is high. BA20550 with 8 ohm load the power efficiency can be better than 87%.

Shutdown Mode

The BA20550 provides a shutdown mode for reduce supply current to the absolute minimum level during periods of nonuse for battery-power conservation. The SHUTDOWN_B input pin should be held high during normal operation when the amplifier is in use. Pulling SHUTDOWN_B low causes the outputs to mute and the amplifier to enter a low-current state. SHUTDOWN_B should never be left unconnected because the amplifier state would be unpredictable.

SHUTDOWN_B pin recommends connect 100K Ohm To VDD & Connect 0.1uF To Ground.

Differential Input

The differential input stage of the amplifier cancels any noise that appears on both input lines of the channel. To use the BA20550 with a differential source, connect the positive lead of the audio source to the LINP/RINP input and the negative lead from the audio source to the LINN/RINN input. To use the BA20550 with a single-ended source, ac ground either input through a capacitor and apply the audio signal to the remaining input. In a single-ended input application, the unused input should be ac-grounded at the audio source instead of at the device input for best noise performance.

Single-end stereo input application circuit shows in Figure 2. It's recommended LINN & RINN connect 0.1uF~1uF to ground. & Left/Right analog audio signal series connect 0.1uF~1uF to LINP & RINP.

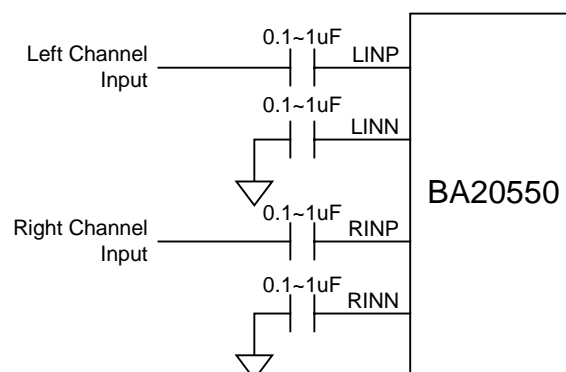

Figure 2. Single-end stereo input application circuit

Volume Control

The VOLUME pin controls the volume of the BA20550. It is controlled with a dc voltage, which should not exceed VDD. Table 1 lists the voltage on the VOLUME pin and the corresponding gain.

The volume control circuitry of the BA20550 is internally referenced to the VDD and 0V. Any common-mode noise between the VOLUME terminal and these terminals will be sensed by the volume control circuitry. If the noise exceeds the step size voltage, the gain will change. In order to minimize this effect, care must be taken to ensure the signal driving the VOLUME terminal is referenced to the VDD and 0V of the BA20550.

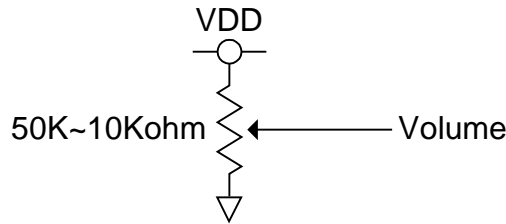

Figure 3. DC Volume Application Circuit

Table 1. Typical DC Volume Control

Voltage On Volume Pin	Typical Gain Of Amplifier (dB)
0.97 - 0.87	-27
1.08 - 0.98	-25
1.19 - 1.09	-23
1.32 - 1.20	-21
1.42 - 1.33	-19
1.53 - 1.43	-17
1.63 - 1.54	-15
1.75 - 1.64	-13
1.84 - 1.76	-12
1.96 - 1.85	-10
2.09 - 1.97	-8
2.19 - 2.10	-6
2.33 - 2.20	-4
2.43 - 2.34	-2
2.49 - 2.44	0
2.62 - 2.50	2
2.75 - 2.63	4
2.85 - 2.76	6
2.99 - 2.86	8
3.12 - 3.00	10
3.25 - 3.13	12
3.36 - 3.26	14
3.48 - 3.37	16
3.64 - 3.49	18
VDD - 3.65	20

COSC & ROSC Pin

The switching frequency is determined using the values of the components connected to ROSC and COSC. The frequency may be varied from 200 kHz to 300 kHz by adjusting the values chosen for ROSC and COSC. The recommended values are COSC = 220 pF, ROSC= 120 k Ω for a switching frequency of 250 kHz.

Over-Heat Protection

Over-Heat protection on the BA20550 prevents damage to the device when the internal die temperature exceeds 125°C. Once the die temperature exceeds the thermal set point, the device enters the shutdown state and the outputs are disabled. The device will back to normal operation when die temperature is reduced without external system interaction.

Output Short Protection

The BA2037 has output short circuit protection circuitry on the outputs that prevents damage to the device during output-to-output short, output-to-GND short, and output-to-VDD short. BA20550 enter the shutdown state and the outputs are disabled when detects output short. This is a latched fault and must be reset by cycling the voltage on SHUTDOWN_B pin to a logic low and back to the logic high, or by cycling the power off and then back on. This clears the short circuit flag and allows for normal operation if the short was removed. If the short war not removed, the protection circuitry actives again.

Anti-Pop

A soft start capacitor must be added to the BYPASS pin. It recommends connect a capacitor of 1uF from BYPASS pin to Ground. BA20550 provides fade-in function when power-on or SHUTDOWN_B input voltage level from 0V to VDD, and fade-out function when SHUTDOWN_B input voltage level from VDD to 0V. The pop noise can be eliminated by fade-in/fade-out function.

Output Filter Application Note

Design the BA20550 without the filter if the traces from amplifier to speaker are short (< 1 inch). Where the speaker is in the same enclosure as the amplifier is a typical application for class-d without a filter.

Many applications require a ferrite bead filter. The ferrite filter reduces EMI around 30 MHz. When selecting a ferrite bead, choose one with high impedance at high frequencies, but low impedance at low frequencies.

Use an LC output filter if there are low frequency (<1 MHz) EMI sensitive circuits and there are long wires from the amplifier to the speaker.

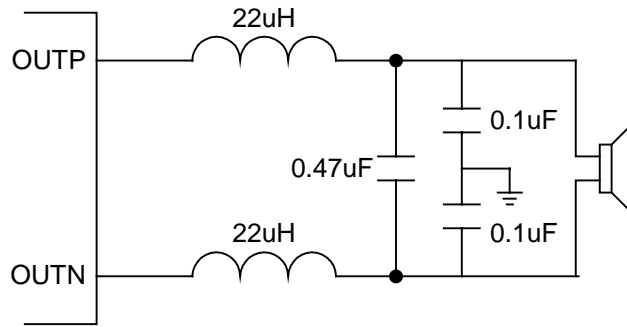

Figure 4. Typical LC Output Filter

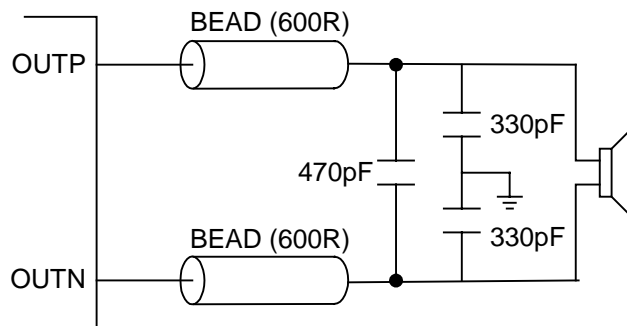

Figure 5. Typical Ferrite Chip Bead Output Filter

BYPASS Pin

It's recommended to connect a 1uF ceramic or tantalum low-ESR capacitor from BYPASS pin to ground for internal bias reference. This capacitor can provide high power supply rejection ratio (PSRR) and the best audio performance.

Typical Characteristics

Table of Graphs

Figure No.	Description	Output Load	
6	Frequency Response	3 Ω	
7			5V, 0.5W Output
8			5V, 1W Output
9			5V, 2W Output
10	Frequency Response	4 Ω	
11			3.9V, 0.5W Output
12			5V, 0.5W Output
13			5V, 1W Output
14	Frequency Response	8 Ω	
15			5V, 2W Output
16			3.9V, 0.5W Output
17	THD+N VS. Frequency	3 Ω	
18			5V, 0.5W Output
19			5V, 1W Output
20			5V, 2W Output
21	THD+N VS. Frequency	4 Ω	
22			3.9V, 0.5W Output
23			5V, 0.5W Output
24			5V, 1W Output
25	THD+N VS. Frequency	8 Ω	
26			5V, 2W Output
27			3.9V, 0.5W Output
28	THD+N VS. Output Power	3 Ω	
29			5V
30	THD+N VS. Output Power	4 Ω	
31			3.9V
32	THD+N VS. Output Power	8 Ω	
33			5V
34	Crosstalk	3 Ω	
35			3.9V
36	Crosstalk	4 Ω	
37			5V
38	Crosstalk	8 Ω	
39			3.9V

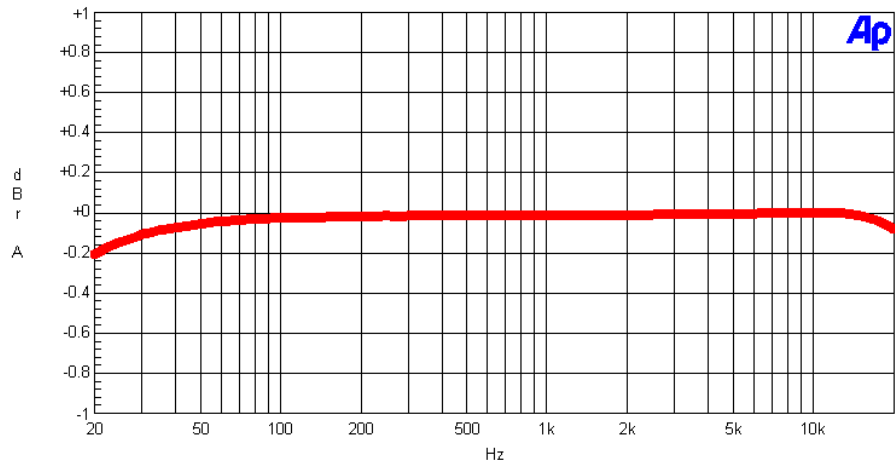
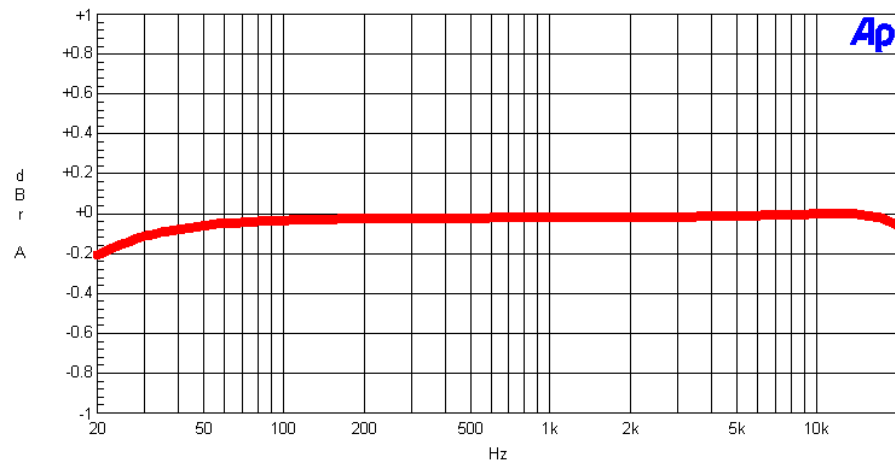
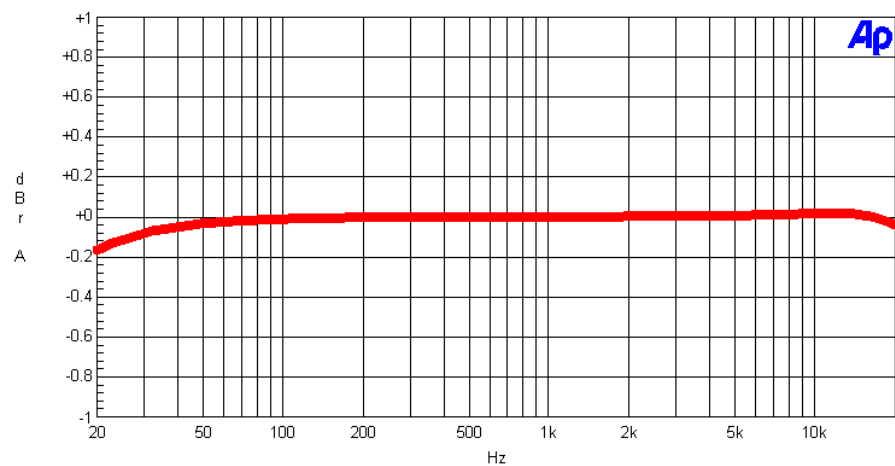
Frequency Response (3Ω Load)**Figure 6: Frequency Response, Operate at 5V, 3Ω Load & 0.5W Output, Volume at 2.5V****Figure 7: Frequency Response, Operate at 5V, 3Ω Load & 1W Output, Volume at 2.5V****Figure 8. Frequency Response, Operate at 5V, 3Ω Load & 2W Output, Volume at 2.5V**

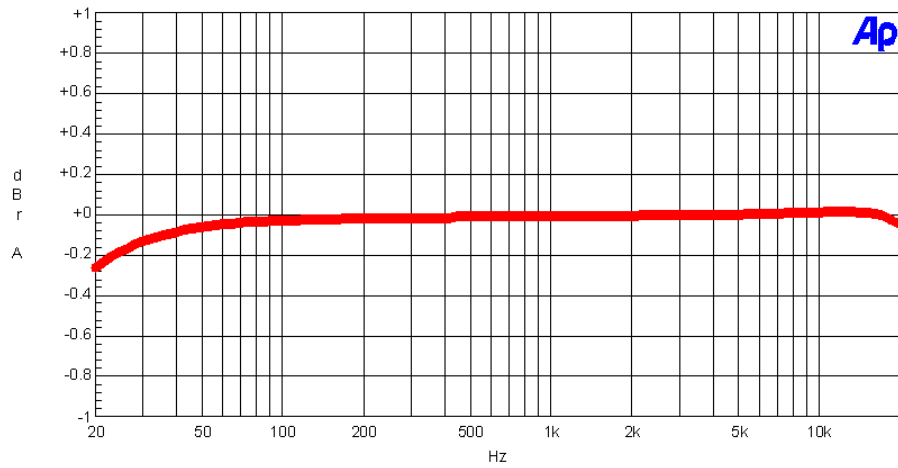

Figure 9. Frequency Response, Operate at 3.9V, 3Ω Load & 0.5W Output, Volume at 2.1V

Frequency Response (4Ω Load)

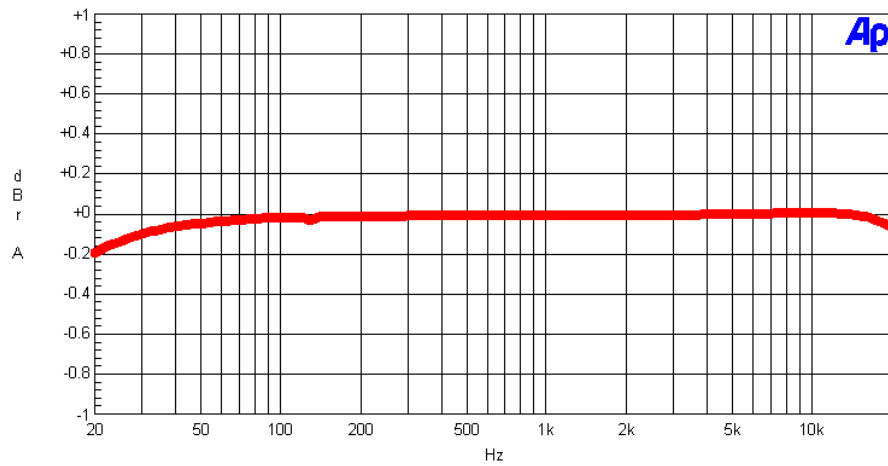

Figure 10. Frequency Response, Operate at 5V, 4Ω Load & 0.5W Output, Volume at 2.5V

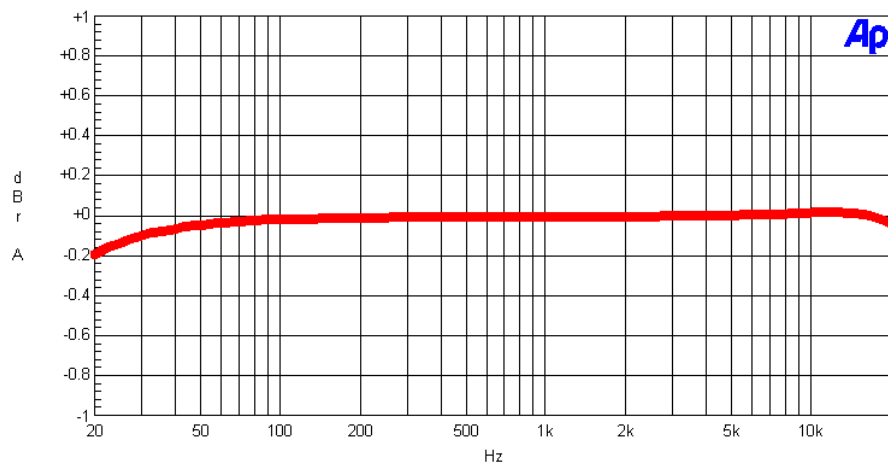

Figure 11. Frequency Response, Operate at 5V, 4Ω Load & 1W Output, Volume at 2.5V

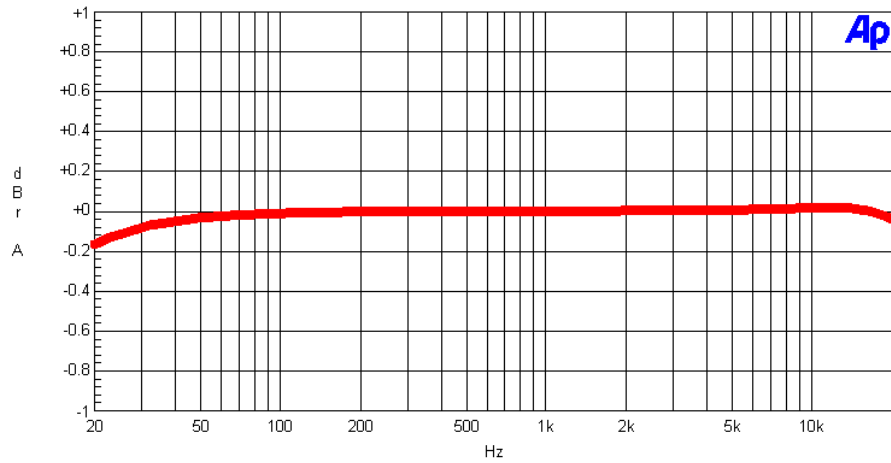

Figure 12. Frequency Response, Operate at 5V, 4Ω Load & 2W Output, Volume at 2.5V

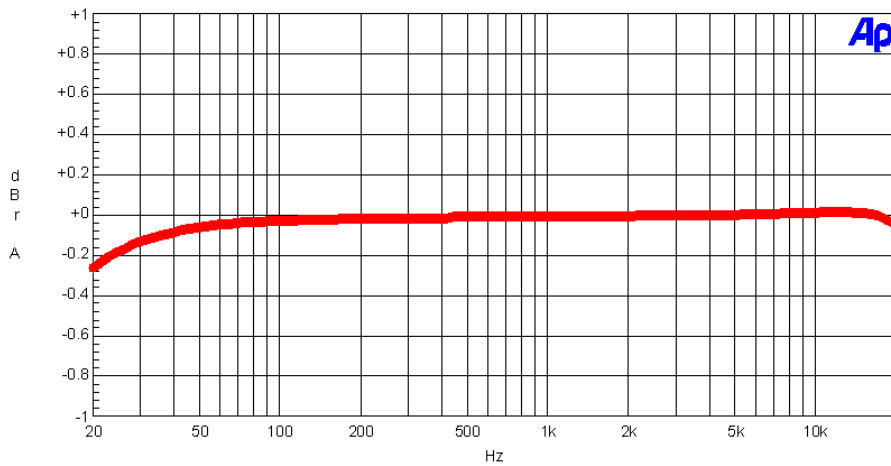

Figure 13. Frequency Response, Operate at 3.9V, 4Ω Load & 0.5W Output, Volume at 2.1V

Frequency Response (8Ω Load)

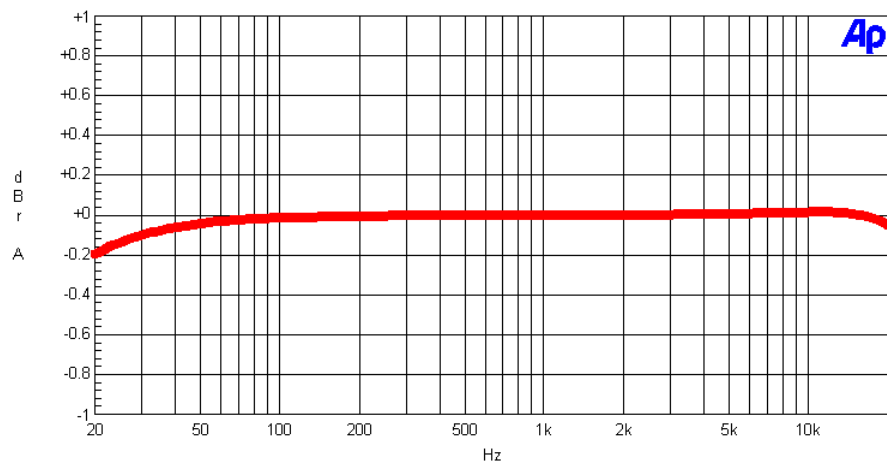

Figure 14. Frequency Response, Operate at 5V, 8Ω Load & 0.5W Output, Volume at 2.7V

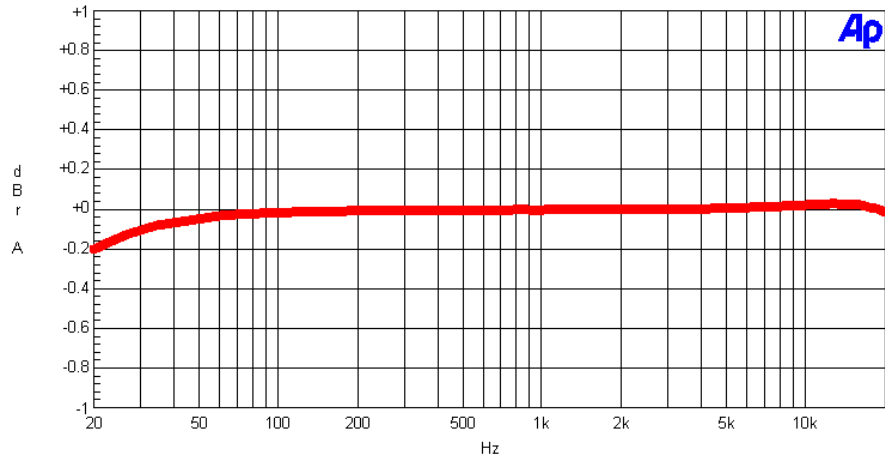

Figure 15. Frequency Response, Operate at 5V, 8Ω Load & 1W Output, Volume at 2.7V

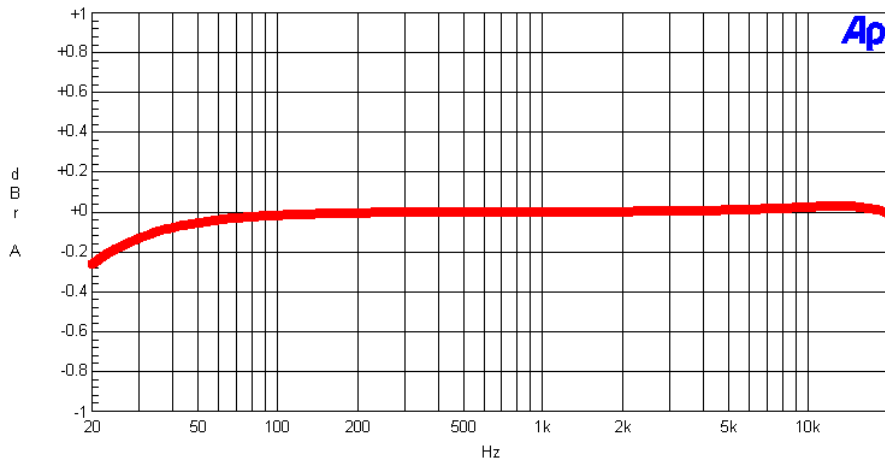

Figure 16. Frequency Response, Operate at 3.9V, 8Ω Load & 0.5W Output, Volume at 2.3V

THD+N VS. Frequency (3Ω Load)

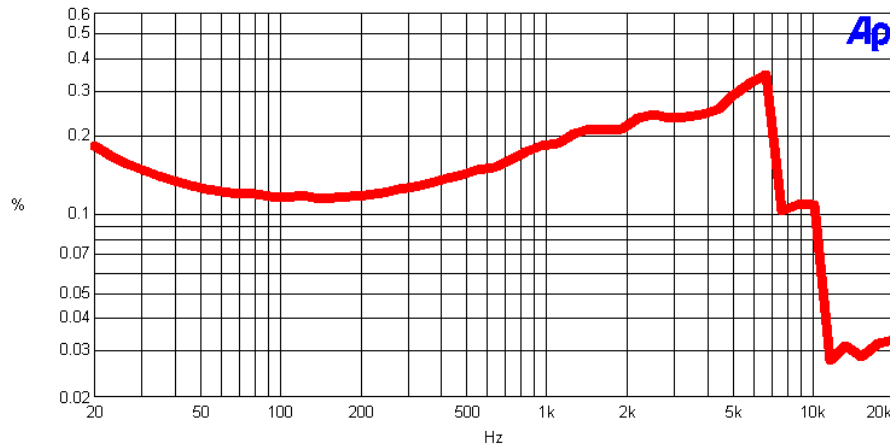

Figure 17. THD+N VS. Frequency, Operate at 5V, 3Ω Load & 0.5W Output, Volume at 2.5V

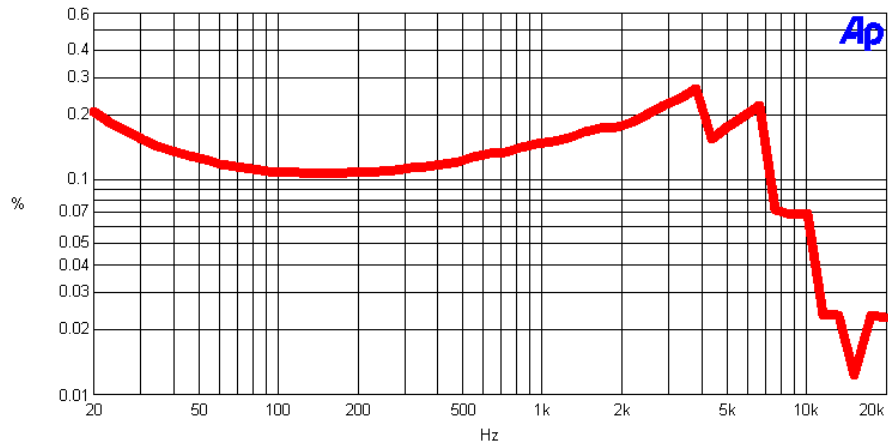

Figure 18. THD+N VS. Frequency, Operate at 5V, 3Ω Load & 1W Output, Volume at 2.5V

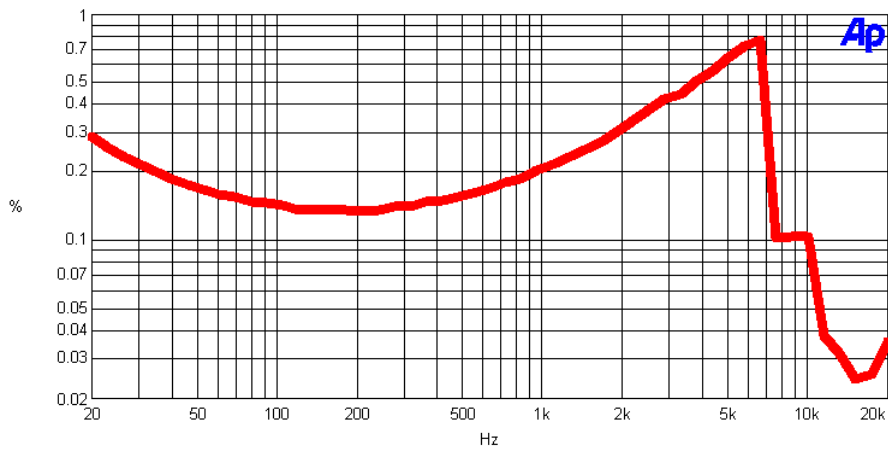

Figure 19. THD+N VS. Frequency, Operate at 5V, 3Ω Load & 2W Output, Volume at 2.5V

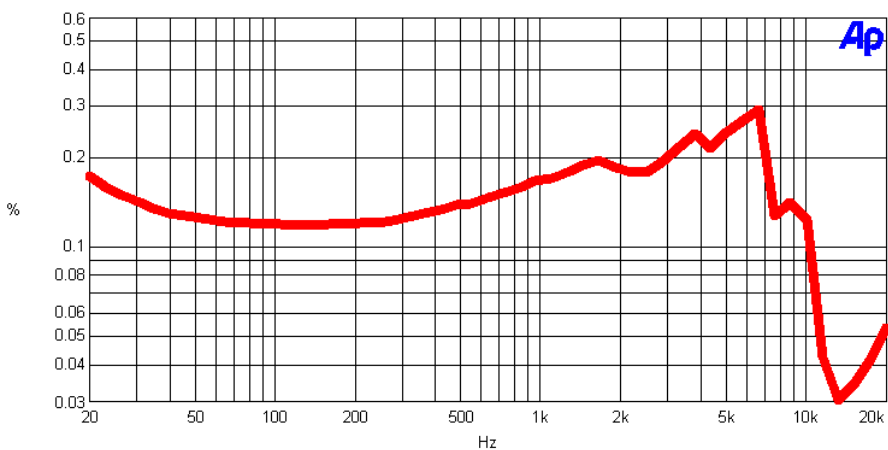
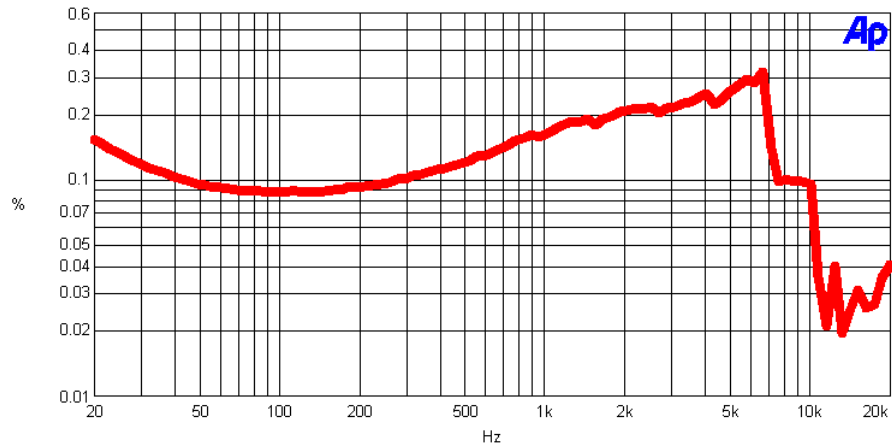
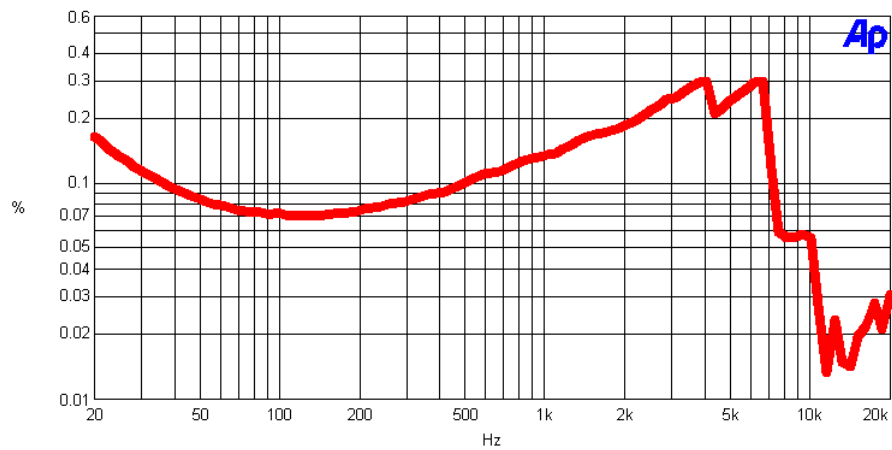
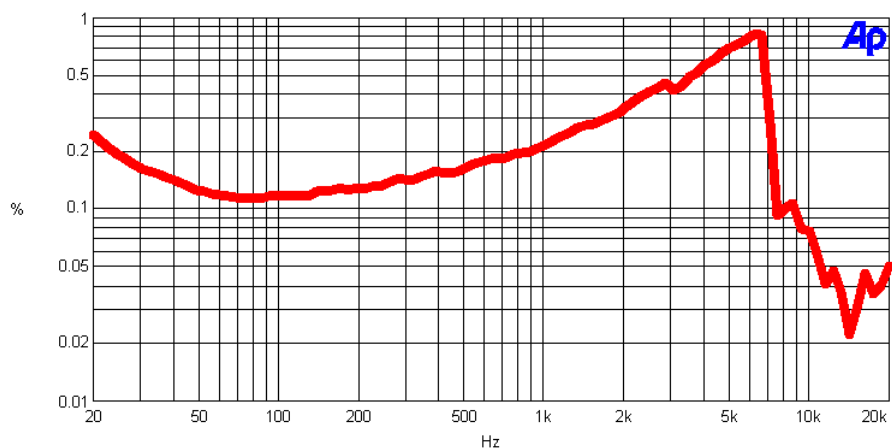

Figure 20. THD+N VS. Frequency, Operate at 3.9V, 3Ω Load & 0.5W Output, Volume at 2.1V

THD+N VS. Frequency (4Ω Load)**Figure 21. THD+N VS. Frequency, Operate at 5V, 4Ω Load & 0.5W Output, Volume at 2.5V****Figure 22. THD+N VS. Frequency, Operate at 5V, 4Ω Load & 1W Output, Volume at 2.5V****Figure 23. THD+N VS. Frequency, Operate at 5V, 4Ω Load & 2W Output, Volume at 2.5V**

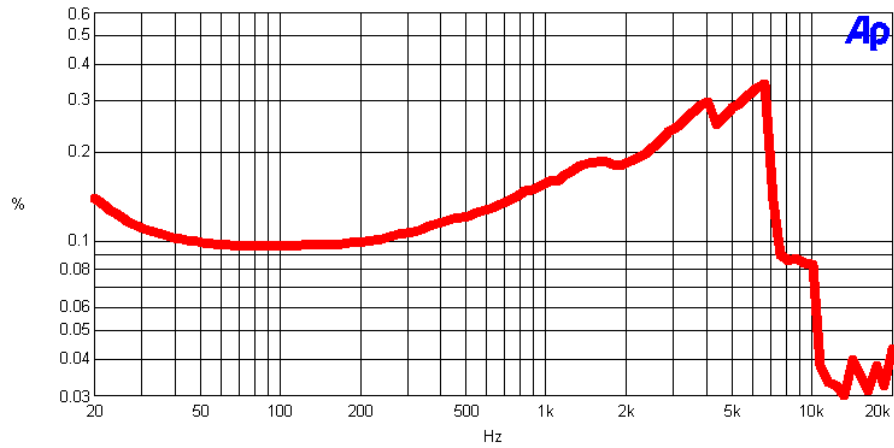

Figure 24. THD+N VS. Frequency, Operate at 3.9V, 4Ω Load & 0.5W Output, Volume at 2.1V

THD+N VS. Frequency (8Ω Load)

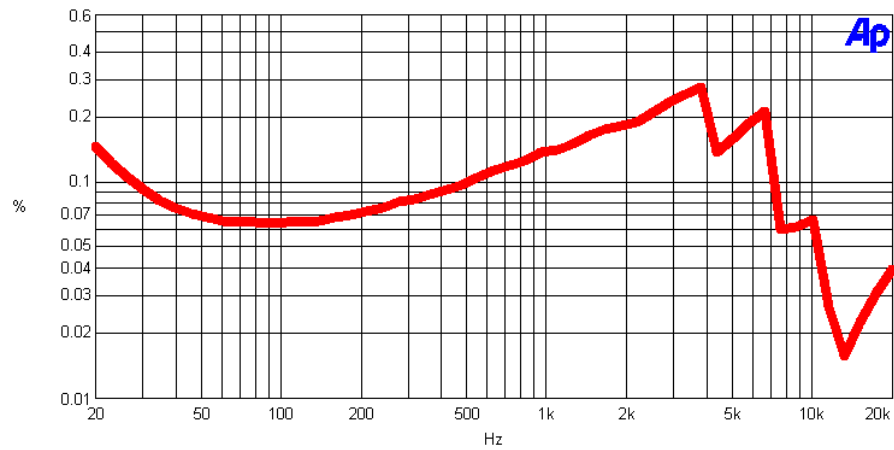

Figure 25. THD+N VS. Frequency, Operate at 5V, 8Ω Load & 0.5W Output, Volume at 2.7V

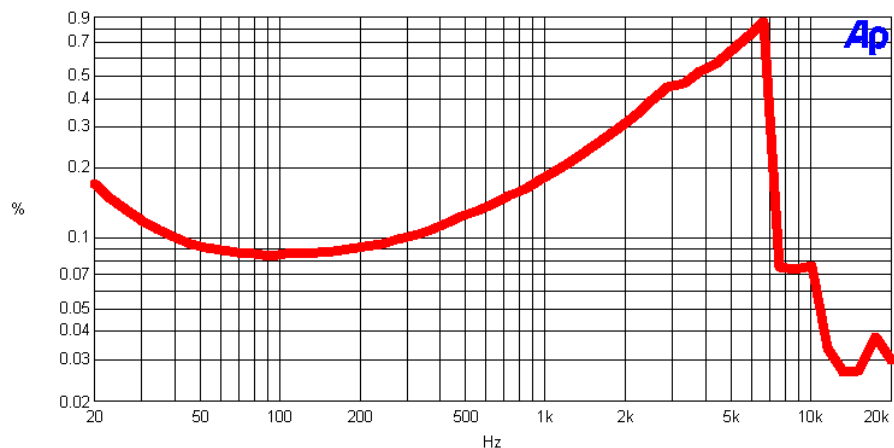

Figure 26. THD+N VS. Frequency, Operate at 5V, 8Ω Load & 1W Output, Volume at 2.7V

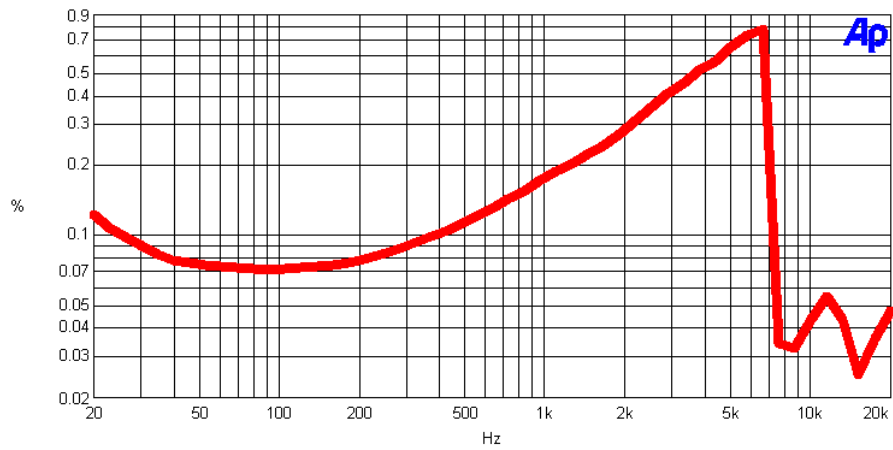

Figure 27. THD+N VS. Frequency, Operate at 3.9V, 8Ω Load & 0.5W Output, Volume at 2.3V

THD+N VS. Output Power (3Ω Load)

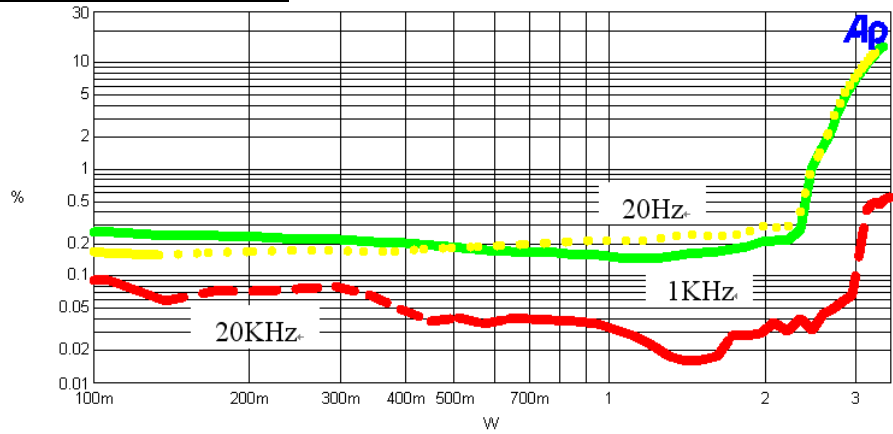

Figure 28. THD+N VS. Output Power, Operate at 5V, 3Ω Load, Volume at 2.5V

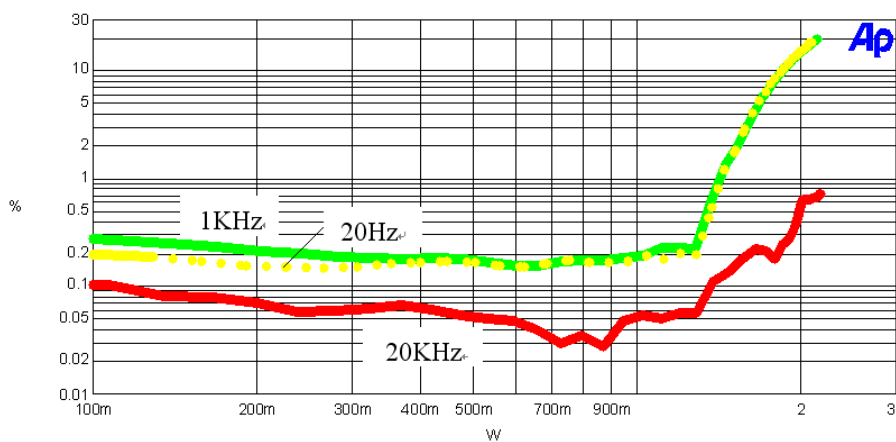

Figure 29. THD+N VS. Output Power, Operate at 3.9V, 3Ω Load, Volume at 2.1V

THD+N VS. Output Power (4Ω Load)

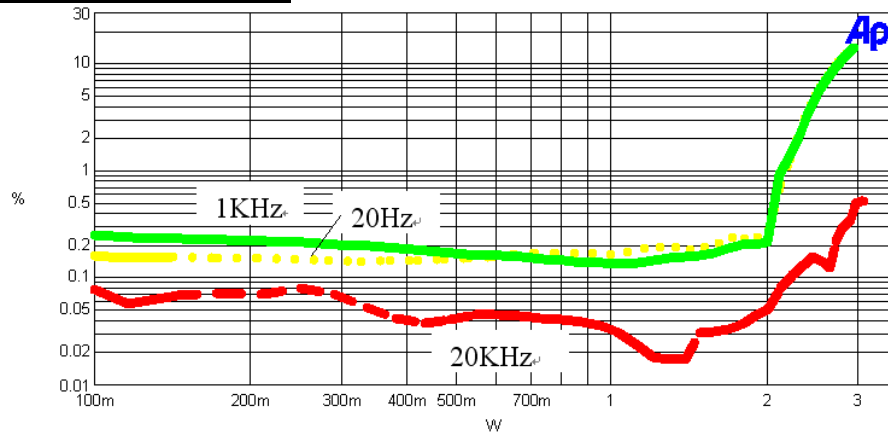

Figure 30. THD+N VS. Output Power, Operate at 5V, 4Ω Load, Volume at 2.5V

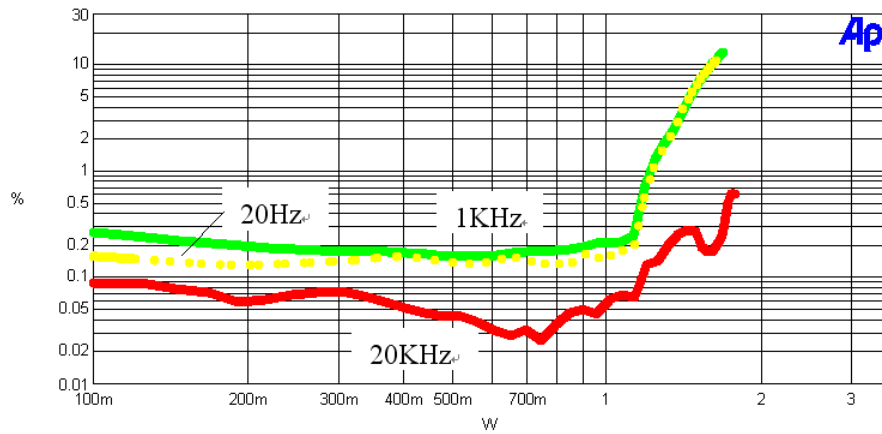

Figure 31. THD+N VS. Output Power, Operate at 3.9V, 4Ω Load, Volume at 2.1V

THD+N VS. Output Power (8Ω Load)

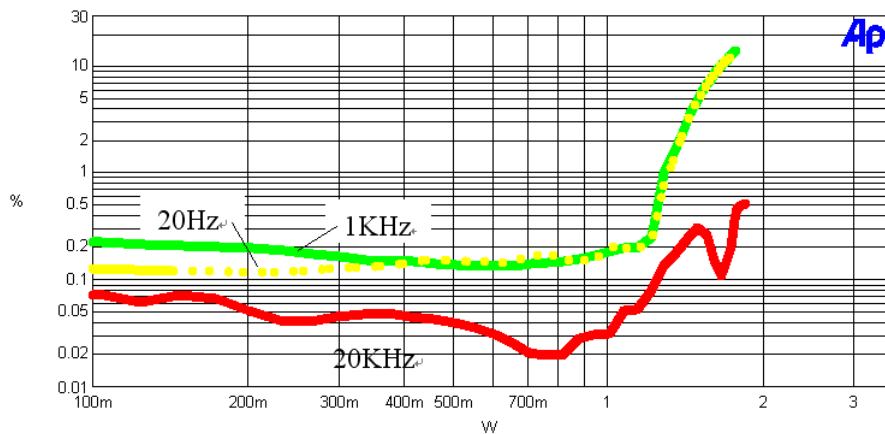

Figure 32. THD+N VS. Output Power, Operate at 5V, 8Ω Load, Volume at 2.7V

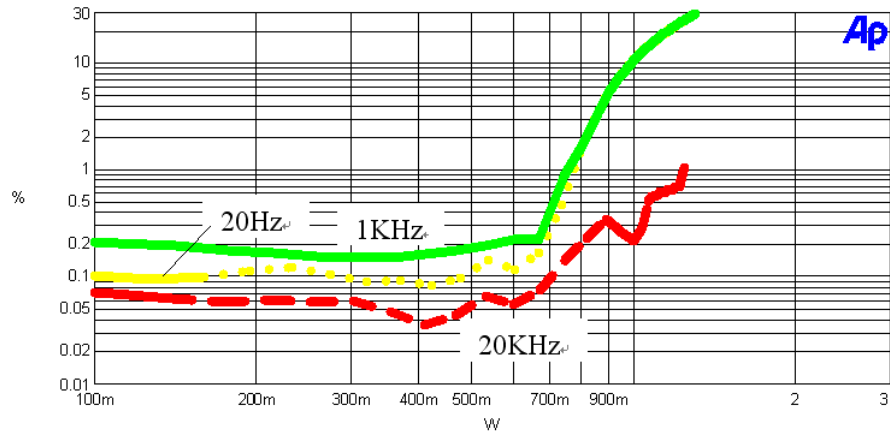

Figure 33. THD+N VS. Output Power, Operate at 3.9V, 8Ω Load, Volume at 2.3V

Crosstalk (3Ω Load)

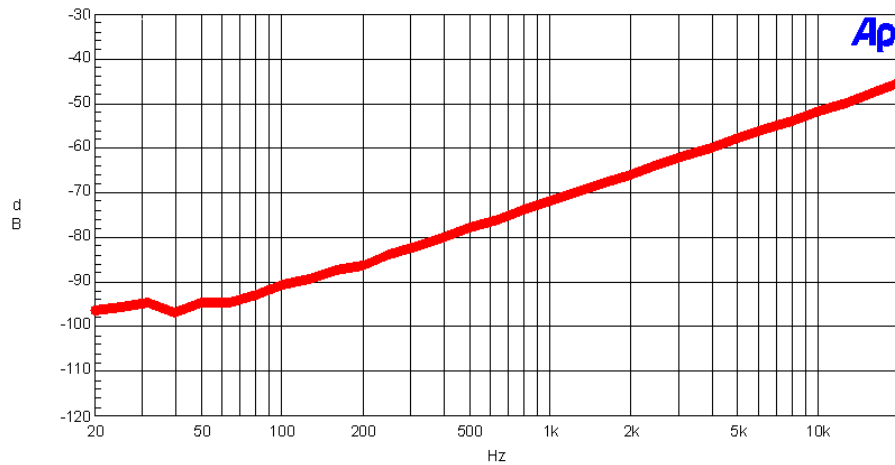

Figure 34. Classtalk, Operate at 5V, 3Ω Load, Output Power at 2.3W, Volume at 2.5V

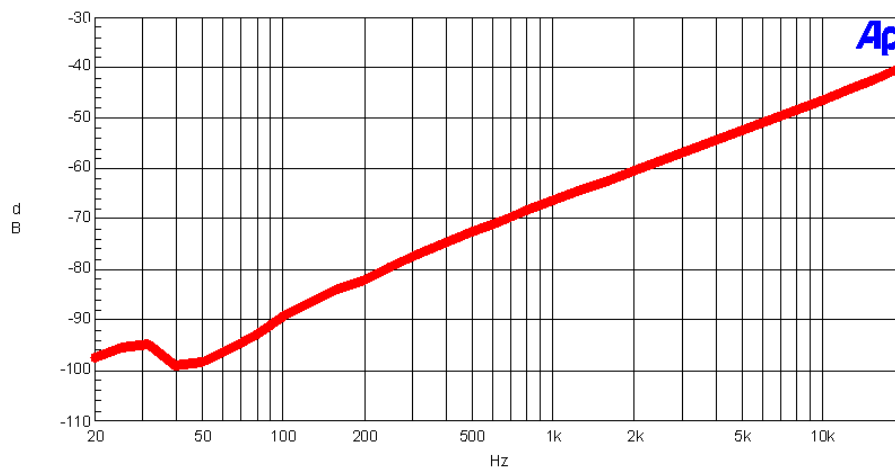

Figure 35. Classtalk, Operate at 3.9V, 3Ω Load, Output Power at 1.8W, Volume at 2.1V

Crosstalk (4Ω Load)

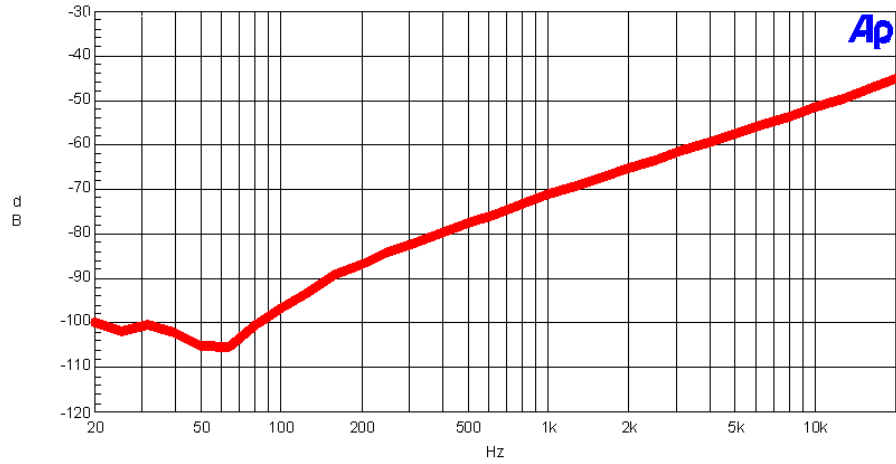

Figure 36. Classtalk, Operate at 5V, 4Ω Load, Output Power at 2.4W, Volume at 2.5V

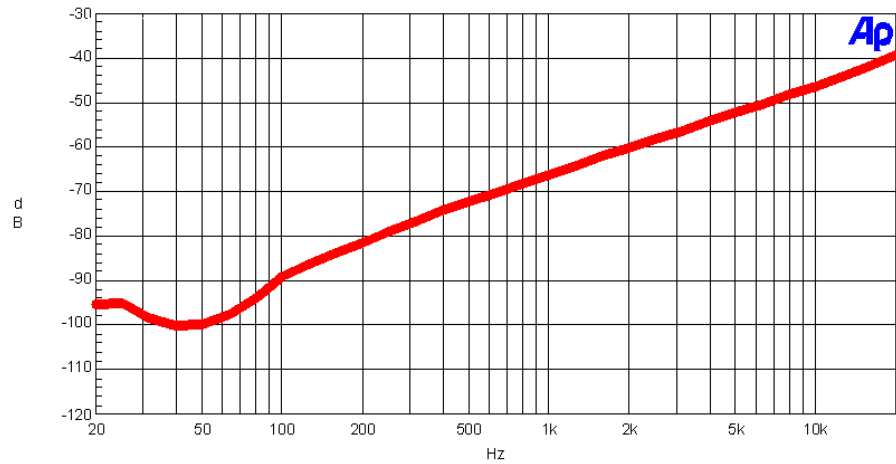

Figure 37. Classtalk, Operate at 3.9V, 4Ω Load, Output Power at 1.5W, Volume at 2.1V

Crosstalk (8Ω Load)

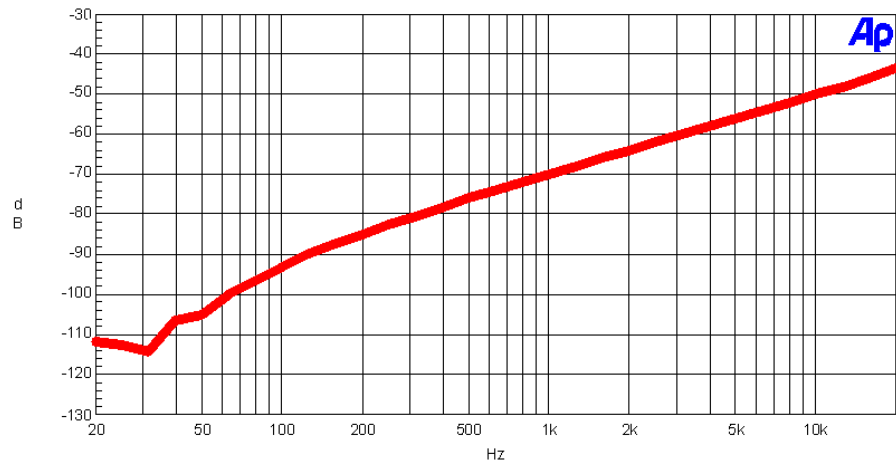

Figure 38. Classtalk, Operate at 5V, 8Ω Load, Output Power at 1.65W, Volume at 2.7V

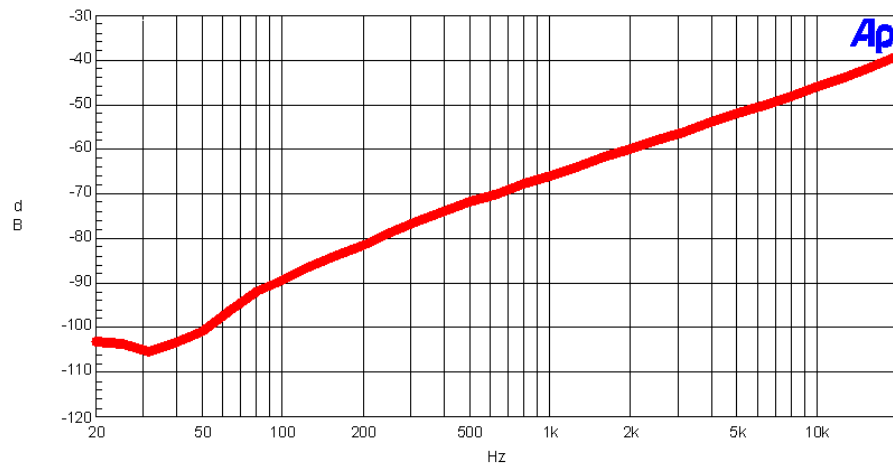
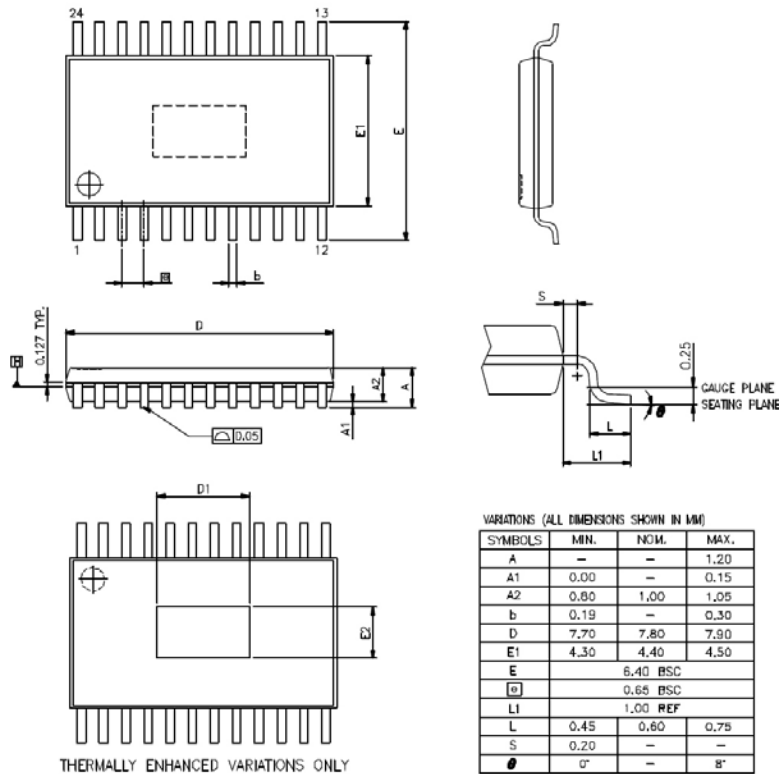

Figure 39. Classtalk, Operate at 3.9V, 8Ω Load, Output Power at 1.23W, Volume at 2.3V

PACKAGE DIMENSION

TSSOP24



- NOTES:
1. JEDEC OUTLINE : MO-153 AD/MO-153 ADT(THERMALLY ENHANCED VARIATIONS ONLY)
 2. DIMENSION 'D' DOES NOT INCLUDE MOLD FLASH, PROTRUSIONS OR GATE BURRS. MOLD FLASH, PROTRUSIONS OR GATE BURRS SHALL NOT EXCEED 0.15 PER SIDE.
 3. DIMENSION 'E1' DOES NOT INCLUDE INTERLEAD FLASH OR PROTRUSION. INTERLEAD FLASH OR PROTRUSION SHALL NOT EXCEED 0.25 PER SIDE.
 4. DIMENSION 'b' DOES NOT INCLUDE DAMBAR PROTRUSION. ALLOWABLE DAMBAR PROTRUSION SHALL BE 0.08 MM TOTAL IN EXCESS OF THE 'b' DIMENSION AT MAXIMUM MATERIAL CONDITION. DAMBAR CANNOT BE LOCATED ON THE LOWER RADIUS OF THE FOOT. MINIMUM SPACE BETWEEN PROTRUSION AND ADJACENT LEAD IS 0.07 MM.

5. DIMENSIONS 'D' AND 'E1' TO BE DETERMINED AT DATUM PLANE □.

THERMALLY ENHANCED DIMENSIONS(SHOWN IN MM)		
PAD SIZE	E2	D1
112X18E	1.95 REF	3.61 REF



BA20550

3W Stereo Class-D Audio Power Amplifier

TEL:0755-82863877 13242913995 E-MAIL:panxia168@126.com